

PRODUCT CARD

ORDER CODE	MTIC007HV2
PRODUCT WEIGHT (Kg)	

TRANSFORMER

STOCK CODE	1012900598
TRANSFORMER POWER	7 kVA
INPUT - OUTPUT TYPE	1 PHASE
POWER FACTOR	PF 1
INPUT VOLTAGE	220 VAC Ph+N /
OUTPUT VOLTAGE	220 VAC Ph+N /
SIZE(mm)(WxHxD)	340 x 290 x 156
FREQUENCY	50 Hz
WIRE TYPE	ALUMINIUM
WEIGHT (Kg)	~60

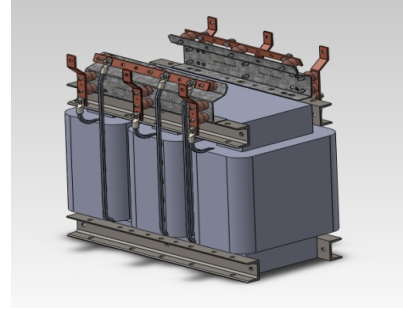

CHASSIS

CHASSIS CODE	MKGT0006-FMP
SIZE(mm)(WxHxD)	625 x 800 x 495
MECHANICAL PROTECTION CLASS	IP20
WEIGHT (Kg)	~

