

PRODUCT CARD

ORDER CODE	MTIC012HV1
PRODUCT WEIGHT (Kg)	~93

TRANSFORMER

STOCK CODE	1012900624
TRANSFORMER POWER	12 KVA
INPUT - OUTPUT TYPE	Y - Y
POWER FACTOR	PF 0,8
INPUT VOLTAGE	220 VAC Ph+N / 380 VAC Ph+Ph
OUTPUT VOLTAGE	220 VAC Ph+N / 380 VAC Ph+Ph
SIZE(mm)(WxHxD)	412 x 220 x 232
FREQUENCY	50Hz
WIRE TYPE	ALUMINIUM
WEIGHT (Kg)	~93

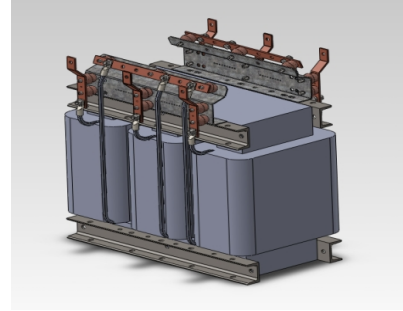

CHASSIS

CHASSIS CODE	MKGT0014-FMP
SIZE(mm)(WxHxD)	650 x 370 x 564
MECHANICAL PROTECTION CLASS	IP20
WEIGHT (Kg)	~

