

PRODUCT CARD

ORDER CODE	MTIC036HV1
PRODUCT WEIGHT (Kg)	~157

TRANSFORMER

STOCK CODE	1012900619
TRANSFORMER POWER	36 kVA
INPUT - OUTPUT TYPE	Y - Y
POWER FACTOR	PF 0,8
INPUT VOLTAGE	220 VAC Ph+N / 380 VAC Ph+Ph
OUTPUT VOLTAGE	220 VAC Ph+N / 380 VAC Ph+Ph
SIZE(mm)(WxHxD)	426 x 410 x 246
FREQUENCY	50 Hz
WIRE TYPE	ALUMINIUM
WEIGHT (Kg)	~157

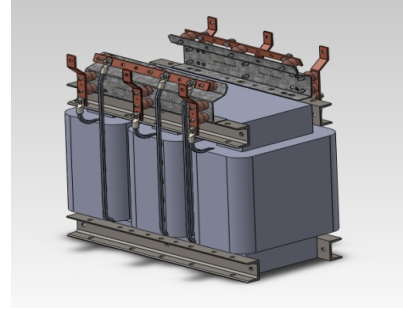

CHASSIS

CHASSIS CODE	MKGT0011-FMP
SIZE(mm)(WxHxD)	600 x 700 x 638
MECHANICAL PROTECTION CLASS	IP20
WEIGHT (Kg)	~

