

PRODUCT CARD

ORDER CODE	MTIC072HV1
PRODUCT WEIGHT (Kg)	~320

TRANSFORMER

STOCK CODE	1012900665
TRANSFORMER POWER	72 kVA
INPUT - OUTPUT TYPE	Y - Y
POWER FACTOR	PF 0,8
INPUT VOLTAGE	220 VAC Ph+N / 380 VAC Ph+Ph
OUTPUT VOLTAGE	220 VAC Ph+N / 380 VAC Ph+Ph
SIZE(mm)(WxHxD)	600 X 550 X 240
FREQUENCY	50 Hz
WIRE TYPE	ALUMINIUM
WEIGHT (Kg)	~320

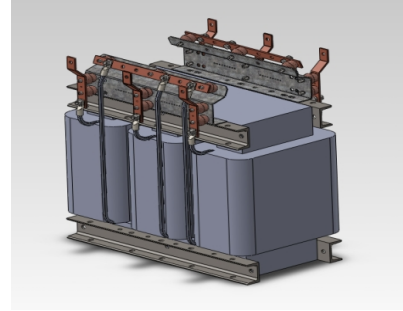

CHASSIS

CHASSIS CODE	MKGT0013-FMP
SIZE(mm)(WxHxD)	905 x 874 x 792
MECHANICAL PROTECTION CLASS	IP20
WEIGHT (Kg)	~

