

PRODUCT CARD

ORDER CODE	MTIC150HV4
PRODUCT WEIGHT (Kg)	~530

TRANSFORMER

STOCK CODE	1012900553
TRANSFORMER POWER	150 kVA
INPUT - OUTPUT TYPE	Y - Y
POWER FACTOR	PF 1
INPUT VOLTAGE	230 VAC Ph+N / 400 VAC Ph-Ph
OUTPUT VOLTAGE	230 VAC Ph+N / 400 VAC Ph-Ph
SIZE(mm)(WxHxD)	650 x 650 x 300
FREQUENCY	50 Hz
WIRE TYPE	ALUMINIUM
WEIGHT (Kg)	~530

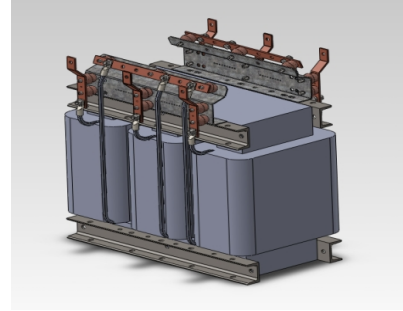

CHASSIS

CHASSIS CODE	MKGT0008-FMP
SIZE(mm)(WxHxD)	905 x 1000 x 792
MECHANICAL PROTECTION CLASS	IP20
WEIGHT (Kg)	~

